



# 2-Channel Headset/Microphone EMI Filter Array with ESD Protection

## CM1412

### Features

- Functionally and pin compatible with CMD's CSPEMI202A
- *OptiGuard*™ coated for improved reliability at assembly
- Two channels of EMI filtering
- Pi-style EMI filters in a capacitor-resistor-capacitor (C-R-C) network
- Greater than 40dB attenuation at 1GHz
- $\pm 8\text{kV}$  ESD protection on each channel (IEC 61000-4-2 Level 4, contact discharge)
- $\pm 15\text{kV}$  ESD protection on each channel (HBM)
- Supports AC signals—ideal for audio applications
- Chip Scale Package features extremely low lead inductance for optimum filter and ESD performance
- 5-bump, 0.930mm X 1.410mm footprint Chip Scale Package (CSP)
- Lead-free RoHS compliant

### Applications

- EMI filtering and ESD protection for headset microphone ports
- Wireless handsets
- Handheld PCs / PDAs
- MP3 players
- Digital camcorders
- Notebooks
- Desktop PCs

### Product Description

The CM1412 is a dual, low-pass filter array integrating two pi-style filters (C-R-C) that reduce EMI/RFI emissions while providing ESD protection. This part is custom-designed to interface with a microphone port on a cellular telephone or similar device. Each high quality filter provides more than 35dB attenuation in the 800 to 2700 MHz range. These pi-style filters support bidirectional filtering that control EMI both to and from a microphone element. They also support AC signals, enabling audio signals to pass through without distortion.

In addition, the CM1412 provides a very high level of protection for sensitive electronic components that may be subjected to electrostatic discharge (ESD). The input pins safely dissipate ESD strikes of  $\pm 8\text{kV}$ , the maximum requirement of the IEC 61000-4-2 international standard. Using the MIL-STD-883 (Method 3015) specification for Human Body Model (HBM) ESD, the device provides protection for contact discharges to greater than  $\pm 15\text{kV}$ .

The CM1412 is particularly well suited for portable electronics (e.g., cellular telephones, PDAs, notebook computers) because of its small package format and low weight. The CM1412 incorporates *OptiGuard*™ coating which results in improved reliability at assembly and is available in a space-saving, low-profile Chip Scale Package with lead-free finishing.

### Block Diagram

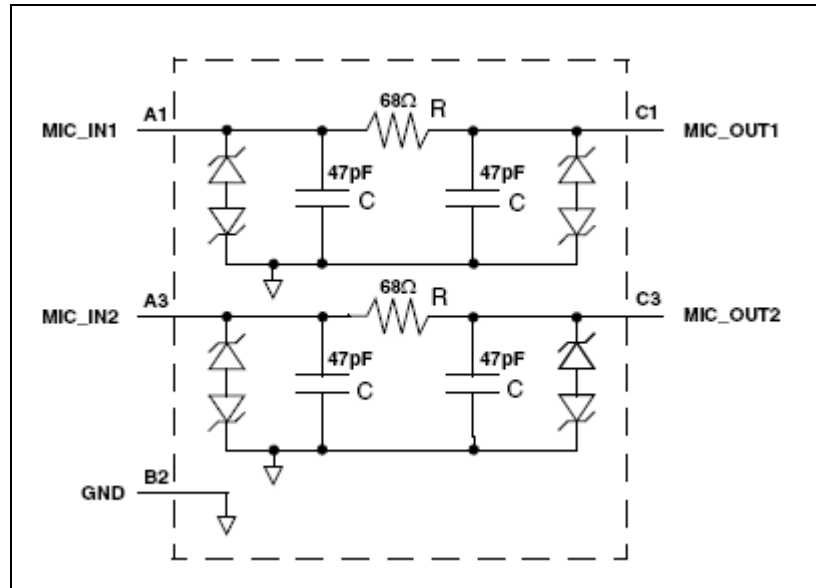

PIN DESCRIPTIONS		
PIN	NAME	DESCRIPTION
A1	MIC_IN1	Microphone Input 1 (from microphone)
A3	MIC_IN2	Microphone Input 2 (from microphone)
B2	GND	Device Ground
C1	MIC_OUT1	Microphone Output 1 (to audio circuitry)
C3	MIC_OUT2	Microphone Output 2 (to audio circuitry)

CM1412

## Ordering Information

PART NUMBERING INFORMATION			
Bumps	Package	Lead-free Finish	
		Ordering Part Number <sup>1</sup>	Part Marking
5	CSP	CM1412-03CP	CB

Note 1: Parts are shipped in Tape & Reel form unless otherwise specified.

## Specifications

ABSOLUTE MAXIMUM RATINGS		
PARAMETER	RATING	UNITS
Storage Temperature Range	-65 to +150	°C
DC Power per Resistor	100	mW
DC Package Power Rating	200	mW

STANDARD OPERATING CONDITIONS		
PARAMETER	RATING	UNITS
Operating Temperature Range	-40 to +85	°C

### ELECTRICAL OPERATING CHARACTERISTICS (NOTE 1)

SYMBOL	PARAMETER	CONDITIONS	MIN	TYP	MAX	UNITS
R	Resistance		61	68	75	$\Omega$
R <sub>MATCH</sub>	Resistance Matching				5	%
C	Capacitance		38	47	56	pF
I <sub>LEAK</sub>	Diode Leakage Current	V <sub>IN</sub> =5.0V			1.0	$\mu$ A
V <sub>SIG</sub>	Signal Voltage Positive Clamp Negative Clamp	I <sub>LOAD</sub> = 10mA	5 -15	7 -10	15 -5	V V
V <sub>ESD</sub>	In-system ESD Withstand Voltage a) Human Body Model, MIL-STD-883, Method 3015 b) Contact Discharge per IEC 61000-4-2 Level 4	Notes 2 and 4	$\pm$ 15 $\pm$ 8			kV kV
V <sub>CL</sub>	Clamping Voltage during ESD Discharge MIL-STD-883 (Method 3015), 8kV Positive Transients Negative Transients	Notes 2,3 and 4		+15 -19		V V
f <sub>C</sub>	Cut-off frequency Z <sub>SOURCE</sub> = 50 $\Omega$ , Z <sub>LOAD</sub> = 50 $\Omega$	R = 68 $\Omega$ , C = 47pF		60		MHz

Note 1: T<sub>A</sub>=25°C unless otherwise specified.

Note 2: ESD applied to input and output pins with respect to GND, one at a time.

Note 3: Clamping voltage is measured at the opposite side of the EMI filter to the ESD pin. For example, if ESD is applied to Pin A1, then clamping voltage is measured at Pin C1.

Note 4: Unused pins are left open.

## Performance Information

Typical Filter Performance (nominal conditions unless specified otherwise, 50 Ohm Environment)

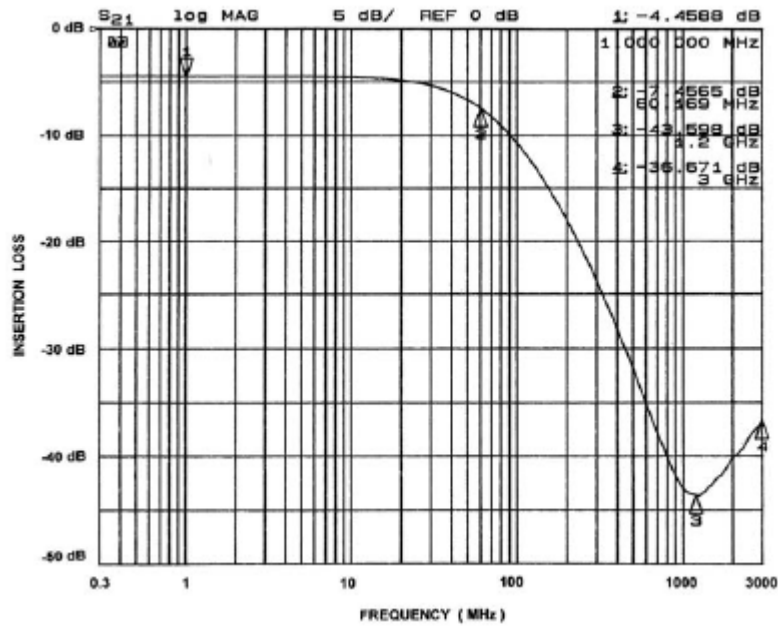

Figure 1. Insertion Loss VS. Frequency (A1-C1 to GND B2)

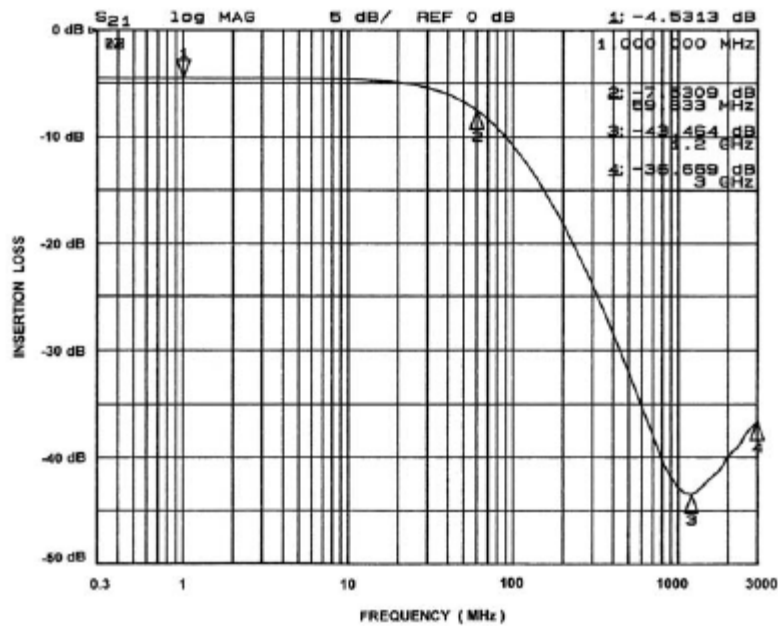

Figure 2. Insertion Loss VS. Frequency (A3-C3 to GND B2)

## Application Information

PARAMETER	VALUE
Pad Size on PCB	0.240mm
Pad Shape	Round
Pad Definition	Non-Solder Mask defined pads
Solder Mask Opening	0.290mm Round
Solder Stencil Thickness	0.125mm - 0.150mm
Solder Stencil Aperture Opening (laser cut, 5% tapered walls)	0.300mm Round
Solder Flux Ratio	50/50 by volume
Solder Paste Type	No Clean
Pad Protective Finish	OSP (Entek Cu Plus 106A)
Tolerance — Edge To Corner Ball	$\pm 50\mu\text{m}$
Solder Ball Side Coplanarity	$\pm 20\mu\text{m}$
Maximum Dwell Time Above Liquidous	60 seconds
Maximum Soldering Temperature for Lead-free Devices using a Lead-free Solder Paste	260°C

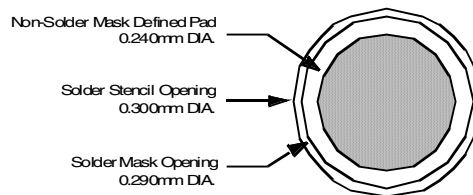

Figure 5. Recommended Non-Solder Mask Defined Pad Illustration

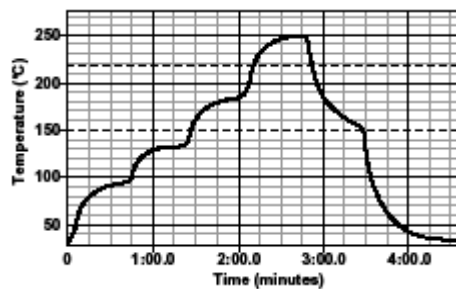

Figure 6. Lead-free (SnAgCu) Solder Ball Reflow Profile

# CM1412

## Mechanical Details

### CSP Mechanical Specifications

The CM1411 is supplied in a custom Chip Scale Package (CSP). Dimensions are presented below.

PACKAGE DIMENSIONS						
Package	Custom CSP					
Bumps	5					
Dim	Millimeters			Inches		
	Min	Nom	Max	Min	Nom	Max
A1	0.885	0.930	0.975	0.0348	0.0366	0.0384
A2	1.365	1.410	1.455	0.0537	0.0555	0.0573
B1	0.495	0.500	0.505	0.0195	0.0197	0.0199
B2	0.245	0.250	0.255	0.0096	0.0098	0.0100
B3	0.430	0.435	0.440	0.0169	0.0171	0.0173
B4	0.430	0.435	0.440	0.0169	0.0171	0.0173
C1	0.165	0.215	0.265	0.0065	0.0085	0.0104
C2	0.220	0.270	0.320	0.0087	0.0106	0.0126
D1	0.575	0.644	0.714	0.0226	0.0254	0.0281
D2	0.368	0.419	0.470	0.0145	0.0165	0.0185
# per tape and reel	3500 pieces					
Controlling dimension: millimeters						

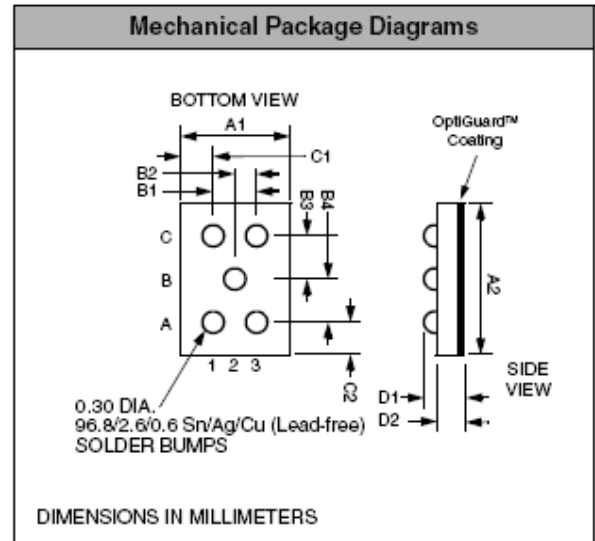

**Package Dimensions for  
CM1412 Chip Scale Package**

**CSP Tape and Reel Specifications**

PART NUMBER	CHIP SIZE (mm)	POCKET SIZE (mm) $B_0 \times A_0 \times K_0$	TAPE WIDTH W	REEL DIAMETER	QTY PER REEL	$P_0$	$P_1$
CM1412	1.41 X 0.95 X 0.644	1.52 X 1.07 X 0.720	8mm	178mm (7")	3500	4mm	4mm

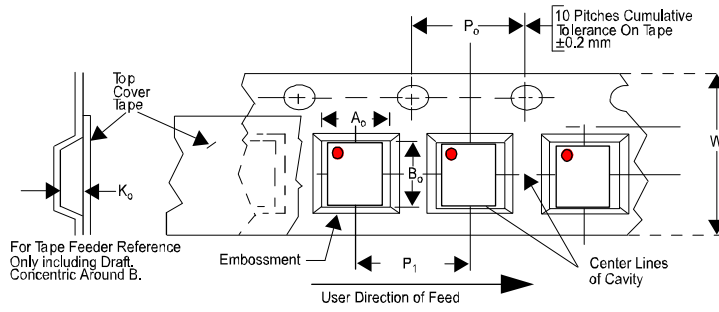

**Figure 5. Tape and Reel Mechanical Data**



ON Semiconductor and  are registered trademarks of Semiconductor Components Industries, LLC (SCILLC). SCILLC reserves the right to make changes without further notice to any products herein. SCILLC makes no warranty, representation or guarantee regarding the suitability of its products for any particular purpose, nor does SCILLC assume any liability arising out of the application or use of any product or circuit, and specifically disclaims any and all liability, including without limitation special, consequential or incidental damages. "Typical" parameters which may be provided in SCILLC data sheets and/or specifications can and do vary in different applications and actual performance may vary over time. All operating parameters, including "Typicals" must be validated for each customer application by customer's technical experts. SCILLC does not convey any license under its patent rights nor the rights of others. SCILLC products are not designed, intended, or authorized for use as components in systems intended for surgical implant into the body, or other applications intended to support or sustain life, or for any other application in which the failure of the SCILLC product could create a situation where personal injury or death may occur. Should Buyer purchase or use SCILLC products for any such unintended or unauthorized application, Buyer shall indemnify and hold SCILLC and its officers, employees, subsidiaries, affiliates, and distributors harmless against all claims, costs, damages, and expenses, and reasonable attorney fees arising out of, directly or indirectly, any claim of personal injury or death associated with such unintended or unauthorized use, even if such claim alleges that SCILLC was negligent regarding the design or manufacture of the part. SCILLC is an Equal Opportunity/Affirmative Action Employer. This literature is subject to all applicable copyright laws and is not for resale in any manner.

## PUBLICATION ORDERING INFORMATION

### LITERATURE FULFILLMENT:

Literature Distribution Center for ON Semiconductor  
P.O. Box 5163, Denver, Colorado 80217 USA  
**Phone:** 303-675-2175 or 800-344-3860 Toll Free USA/Canada  
**Fax:** 303-675-2176 or 800-344-3867 Toll Free USA/Canada  
**Email:** [orderlit@onsemi.com](mailto:orderlit@onsemi.com)

**N. American Technical Support:** 800-282-9855  
Toll Free USA/Canada  
**Europe, Middle East and Africa Technical Support:**  
**Phone:** 421 33 790 2910  
**Japan Customer Focus Center**  
**Phone:** 81-3-5773-3850

ON Semiconductor Website: [www.onsemi.com](http://www.onsemi.com)

Order Literature: <http://www.onsemi.com/orderlit>

For additional information, please contact your local Sales Representative